

NEW
LUMALUX
ILUMINAÇÃO

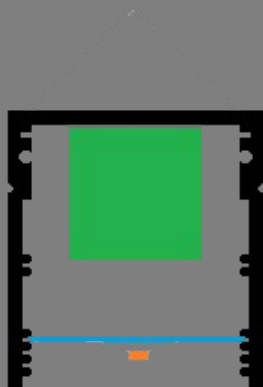
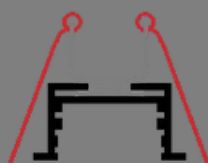
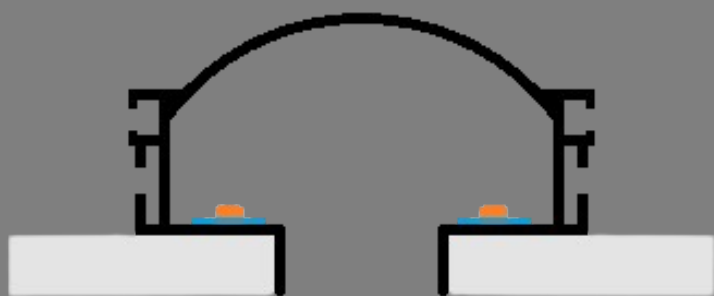

**FITAS &
PERFIS LED**

LINHA 2024

QUALIDADE E INOVAÇÃO

HÁ 17 ANOS A QUALIDADE E A INOVAÇÃO FAZEM PARTE DO DIA A DIA DA NEW LUMALUX.

COM UM PARQUE FABRIL DE MAIS DE 2.500M² - LOCALIZADO NA CIDADE DE SÃO PAULO, HÁ POUCOS METROS DA VIA ANCHIETA E PRÓXIMO AO RODOANEL, QUE DÁ ACESSO ÀS PRINCIPAIS RODOVIAS - DESENVOLVEMOS, FABRICAMOS, IMPORTAMOS E COMERCIALIZAMOS LUMINÁRIAS COM A TECNOLOGIA LED PARA OS MAIS DIVERSOS SEGMENTOS DE MERCADO, SEJA PARA USO INTERNO OU EXTERNO.

COM UM ESTÚDIO PRÓPRIO DE CRIAÇÃO BEM COMO LABORATÓRIO FOTOMÉTRICO, A NEW LUMALUX REALIZA TODOS OS TESTES E ENSAIOS NECESSÁRIOS PARA LEVAR ATÉ SEUS CLIENTES O QUE HÁ DE MAIS MODERNO E TECNOLÓGICO EM ILUMINAÇÃO LED, GARANTINDO TODAS AS ETAPAS DO PROCESSO.

NOSSA EQUIPE TÉCNICA É ALTAMENTE CAPACITADA PARA PRESTAR QUALQUER SUPORTE À ESPECIFICAÇÃO, VENDA E PÓS-VENDA,

COM TUDO ISSO, OS PRODUTOS NEW LUMALUX ILUMINAM HOJE GRANDES OBRAS EM TODO O TERRITÓRIO NACIONAL, EM CLIENTES QUE VÃO DESDE CONSTRUTORAS, ENGENHARIAS, INSTALADORAS, ARQUITETOS, LIGHTING DESIGNERS, SUPERMERCADOS, REDES DE LOJAS, SHOPPINGS CENTERS, ESCRITÓRIOS, RESIDÊNCIAS, CONDOMÍNIOS, POSTOS DE GASOLINA, GINÁSIOS DE ESPORTES, INDÚSTRIAS, REDES METROVIÁRIAS, INSTITUIÇÕES BANCÁRIAS E DE ENSINO.



FÁBRICA NEW LUMALUX

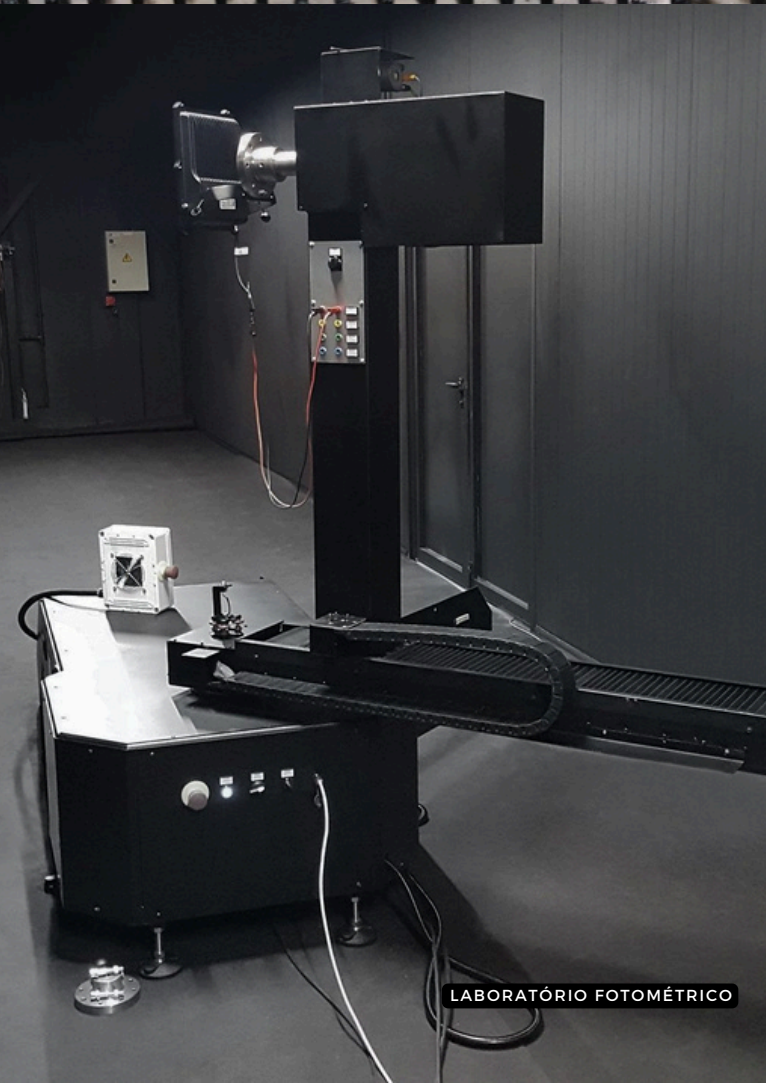

LABORATÓRIO FOTOMÉTRICO



ÍNDICE

BUSCA POR TIPO DE PRODUTO:

FITA LED SMD 12V	PÁG.	5
FITA LED COB 12V	PÁG.	7
FITA LED SMD 24V	PÁG.	9
FITA LED COB 24V	PÁG.	11
PERFIS DE EMBUTIR	PÁG.	13
PERFIS DE SOBREPOR	PÁG.	19
PERFIS PENDENTES	PÁG.	24
PERFIS DE CANTO	PÁG.	29
PERFIS DE PAREDE	PÁG.	32

FITA LED SMD 12V

A FITA LED SMD 12V É FORMADA POR UMA PLACA ELETRÔNICA FLEXÍVEL, ONDE SÃO INTRODUZIDOS DIVERSOS PONTOS DE LED SMD QUE FICAM INTERLIGADOS LINEARMENTE E QUE ATUAM EM BAIXA TENSÃO. ESTÃO DISPONÍVEIS NAS SEGUINTE VERSÕES:

MATERIAL:
PLACA ELETRÔNICA FLEXÍVEL (FITA LED SMD)



DRIVERS DISPONÍVEIS:



DRIVER CHAVEADO
ON/OFF - IP 20

12V X 60W X BI VOLT
12V X 100W X BI VOLT
12V X 120W X BI VOLT
12V X 150W X BI VOLT
12V X 200W X BI VOLT
12V X 250W X BI VOLT
12V X 300W X BI VOLT
12V X 360W X BI VOLT
12V X 400W X BI VOLT
12V X 500W X BI VOLT
12V X 600W X BI VOLT
12V X 1000W X BI VOLT



DRIVER SLIM
ON/OFF - IP 20

12V X 24W X BI VOLT
12V X 36W X BI VOLT
12V X 48W X BI VOLT
12V X 60W X BI VOLT
12V X 72W X BI VOLT



DRIVER ON/OFF
IP 67

12V X 60W X BI VOLT
12V X 72W X BI VOLT
12V X 100W X BI VOLT
12V X 120W X BI VOLT
12V X 150W X BI VOLT
12V X 200W X BI VOLT



DRIVER DIMMER
TRIAC - IP 20

12V X 60W X **110V**
12V X 60W X **220V**
12V X 100W X **110V**
12V X 100W X **220V**
12V X 150W X **110V**
12V X 150W X **220V**
12V X 200W X **110V**
12V X 200W X **220V**

(*) CONSIDERAR SEMPRE 90% DA POTÊNCIA DOS DRIVERS COMO MARGEM DE SEGURANÇA

CONSULTAR DISPONIBILIDADE DE ESTOQUE E TAMANHOS DAS FONTES NO ACEITE DO PEDIDO



25.000H



DIFUSO
120°



VER
DRIVERS
ACIMA



DIMMER SOB
CONSULTA



1 ANO
GARANTIA

FT-SMD12V

"FITA LED 12V" (LED SMD)

POTÊNCIA	LÚMENS	LEDS / M	IRC	IP	T. COR
4,8W / M	480	60 OU 120 LEDS POR M	80 / 90	20	2700K 3000K 4000K
7,2W / M	720	60 / 120 OU 180 LEDS POR M	80 / 90	20 / 65	2700K 3000K 4000K
9,6W / M	960	60 / 120 OU 180 LEDS POR M	80 / 90	20	2700K 3000K 4000K
12W / M	1176	120 LEDS POR M	80	65	3000K 4000K
14,4W / M	1440	60 / 120 OU 156 LEDS POR M	80 / 90	20 / 65	2700K 3000K 4000K
16W / M	1600	240 LEDS POR M	80	20	3000K 4000K
18W / M	1800	240 LEDS POR M	80	20	2700K 3000K 4000K
19,2W / M	1920	60 / 120 OU 180 LEDS POR M	80 / 90	20	2700K 3000K 4000K
20W / M	2000	240 LEDS POR M	90	20	2700K 3000K 4000K
21W / M	2100	240 LEDS POR M	90	20	2700K 3000K 4000K
24W / M	2760	240 LEDS POR M	80	20	2700K 3000K 4000K



LOCAIS DE CORTE INDICADOS NA FITA



OBS.: ROLOS COM 5,0M DE COMPRIMENTO

FITA LED COB 12V

A FITA LED COB 12V É FORMADA POR UMA PLACA ELETRÔNICA FLEXÍVEL, ONDE SÃO INTRODUZIDOS DIVERSOS PONTOS DE LED COB QUE FICAM INTERLIGADOS LINEARMENTE E QUE ATUAM EM BAIXA TENSÃO. ESTÃO DISPONÍVEIS NAS SEGUINTE VERSÕES:

MATERIAL:
PLACA ELETRÔNICA FLEXÍVEL (FITA LED COB)

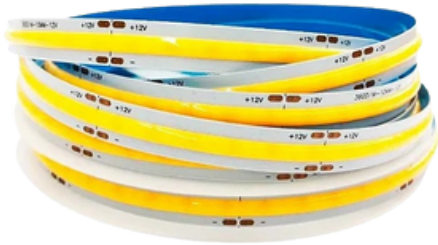

DRIVERS DISPONÍVEIS:



DRIVER CHAVEADO
ON/OFF - IP 20

12V X 60W X BI VOLT
12V X 100W X BI VOLT
12V X 120W X BI VOLT
12V X 150W X BI VOLT
12V X 200W X BI VOLT
12V X 250W X BI VOLT
12V X 300W X BI VOLT
12V X 360W X BI VOLT
12V X 400W X BI VOLT
12V X 500W X BI VOLT
12V X 600W X BI VOLT
12V X 1000W X BI VOLT



DRIVER SLIM
ON/OFF - IP 20

12V X 24W X BI VOLT
12V X 36W X BI VOLT
12V X 48W X BI VOLT
12V X 60W X BI VOLT
12V X 72W X BI VOLT



DRIVER DIMMER
TRIAC - IP 20

12V X 60W X **110V**
12V X 60W X **220V**
12V X 100W X **110V**
12V X 100W X **220V**
12V X 150W X **110V**
12V X 150W X **220V**
12V X 200W X **110V**
12V X 200W X **220V**

(*) CONSIDERAR SEMPRE 90% DA POTÊNCIA DOS DRIVERS COMO MARGEM DE SEGURANÇA

CONSULTAR DISPONIBILIDADE DE ESTOQUE E TAMANHOS DAS FONTES NO ACEITE DO PEDIDO

FT-COB12V

“FITA LED 12V” (LED COB)

POTÊNCIA	LÚMENS	LEDS / M	IRC	IP	T. COR
8W / M	900	480 LEDES POR M	80	20	2700K 3000K 4000K
12W / M	1140	300 LEDES POR M	80 / 90	20	2700K 3000K 4000K
12W / M	1200	512 LEDES POR M	80	20	2700K 3000K 4000K
18W / M	1200	300 LEDES POR M	80 / 90	20	2700K 3000K 4000K



LOCAIS DE CORTE INDICADOS NA FITA

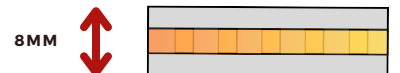

OBS.: ROLOS COM 5,0M DE COMPRIMENTO



25.000H



DIFUSO
120°



VER
DRIVERS
ACIMA



DIMMER SOB
CONSULTA



1 ANO
GARANTIA

FITA LED SMD 24V

A FITA LED SMD 24V É FORMADA POR UMA PLACA ELETRÔNICA FLEXÍVEL, ONDE SÃO INTRODUZIDOS DIVERSOS PONTOS DE LED SMD QUE FICAM INTERLIGADOS LINEARMENTE E QUE ATUAM EM BAIXA TENSÃO. ESTÃO DISPONÍVEIS NAS SEGUINTE VERSÕES:

MATERIAL:
PLACA ELETRÔNICA FLEXÍVEL (FITA LED SMD)



DRIVERS DISPONÍVEIS:



DRIVER CHAVEADO
ON/OFF - IP 20

24V X 60W X BI VOLT
24V X 100W X BI VOLT
24V X 120W X BI VOLT
24V X 150W X BI VOLT
24V X 200W X BI VOLT
24V X 250W X BI VOLT
24V X 300W X BI VOLT
24V X 360W X BI VOLT
24V X 400W X BI VOLT
24V X 500W X BI VOLT
24V X 600W X BI VOLT
24V X 1000W X BI VOLT



DRIVER SLIM
ON/OFF - IP 20

24V X 24W X BI VOLT
24V X 36W X BI VOLT
24V X 48W X BI VOLT
24V X 60W X BI VOLT
24V X 72W X BI VOLT
24V X 100W X BI VOLT
24V X 200W X BI VOLT
24V X 300W X BI VOLT
24V X 400W X BI VOLT



DRIVER DIMMER
TRIAC - IP 20

24V X 60W X 110V
24V X 60W X 220V
24V X 100W X 110V
24V X 100W X 220V
24V X 150W X 110V
24V X 150W X 220V
24V X 200W X 110V
24V X 200W X 220V

(*) CONSIDERAR SEMPRE 90% DA POTÊNCIA DOS DRIVERS COMO MARGEM DE SEGURANÇA

CONSULTAR DISPONIBILIDADE DE ESTOQUE E TAMANHOS DAS FONTES NO ACEITE DO PEDIDO

FT-SMD24V

“FITA LED 24V” (LED SMD)

POTÊNCIA	LÚMENS	LEDS / M	IRC	IP	T. COR
4,8W / M	500 À 560	70 OU 140 LEDES POR M	90	20	2700K 3000K
9,6W / M	1018	140 LEDES POR M	90	20	2700K 3000K
11W / M	1100	378 LEDES POR M	90	20	2700K 3000K
11W / M	1020	120 LEDES POR M	80	20	2700K 4000K
12W / M	1176	120 LEDES POR M	80 / 90	20	2700K 3000K 4000K
12,5W / M	1396	120 LEDES POR M	80	20	2700K 3000K 4000K
14,4W / M	1638	140 / 156 OU 240 LEDES POR M	80 / 90	20	2700K 3000K 4000K
18W / M	1950	240 LEDES POR M	80	20	2700K 4000K
19,2W / M	1920	182 LEDES POR M	90	20	2700K 3000K
22W / M	2568	240 LEDES POR M	80	20	2700K 4000K
24W / M	2760	240 LEDES POR M	80 / 90	20	2700K 3000K 4000K
25W / M	2840	240 LEDES POR M	80	20	2700K 3000K 4000K



LOCAIS DE CORTE INDICADOS NA FITA



OBS.: ROLOS COM 5,0M DE COMPRIMENTO



25.000H



DIFUSO
120°



VER
DRIVERS
ACIMA



DIMMER SOB
CONSULTA



FITA LED COB 24V

A **FITA LED COB 24V** É FORMADA POR UMA PLACA ELETRÔNICA FLEXÍVEL, ONDE SÃO INTRODUZIDOS DIVERSOS PONTOS DE LED **COB** QUE FICAM INTERLIGADOS LINEARMENTE E QUE ATUAM EM BAIXA TENSÃO. ESTÃO DISPONÍVEIS NAS SEGUINTE VERSÕES:

MATERIAL:
PLACA ELETRÔNICA FLEXÍVEL (FITA LED COB)

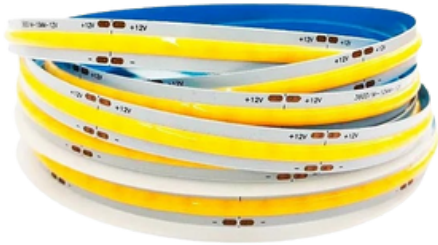

DRIVERS DISPONÍVEIS:



DRIVER CHAVEADO
ON/OFF - IP 20

24V X 60W X BI VOLT
24V X 100W X BI VOLT
24V X 120W X BI VOLT
24V X 150W X BI VOLT
24V X 200W X BI VOLT
24V X 250W X BI VOLT
24V X 300W X BI VOLT
24V X 360W X BI VOLT
24V X 400W X BI VOLT
24V X 500W X BI VOLT
24V X 600W X BI VOLT
24V X 1000W X BI VOLT



DRIVER SLIM
ON/OFF - IP 20

24V X 24W X BI VOLT
24V X 36W X BI VOLT
24V X 48W X BI VOLT
24V X 60W X BI VOLT
24V X 72W X BI VOLT
24V X 100W X BI VOLT
24V X 200W X BI VOLT
24V X 300W X BI VOLT
24V X 400W X BI VOLT



DRIVER DIMMER
TRIAC - IP 20

24V X 60W X 110V
24V X 60W X 220V
24V X 100W X 110V
24V X 100W X 220V
24V X 150W X 110V
24V X 150W X 220V
24V X 200W X 110V
24V X 200W X 220V

(*) CONSIDERAR SEMPRE 90% DA POTÊNCIA DOS DRIVERS COMO MARGEM DE SEGURANÇA

CONSULTAR DISPONIBILIDADE DE ESTOQUE E TAMANHOS DAS FONTES NO ACEITE DO PEDIDO

FT-COB24V

“FITA LED 24V” (LED COB)

POTÊNCIA	LÚMENS	LEDS / M	IRC	IP	T. COR
11,6W / M	1263	352 LEDS POR M	80	20	2700K 3000K 4000K
12W / M	1140	300 LEDS POR M	80 / 90	20	2700K 3000K 4000K
18W / M	1200	300 LEDS POR M	80	20	2700K



LOCAIS DE CORTE INDICADOS NA FITA

8MM



OBS.: ROLOS COM 5,0M DE COMPRIMENTO



25.000H



DIFUSO
120°



VER
DRIVERS
ACIMA



DIMMER SOB
CONSULTA



1 ANO
GARANTIA

PERFIS DE EMBUTIR

O PERFIL **LINEAR LED PFE** É FABRICADO EM DIVERSOS TAMANHOS, ATENDENDO A UMA VARIADA GAMA DE APLICAÇÕES.

MATERIAL:
PERFIL EM ALUMÍNIO EXTRUDADO E DIFUSOR EM POLIESTIRENO TRANSLÚCIDO.

PFE-01

“PERFIL EMBUTIDO” (ESTREITO - FITA LED)

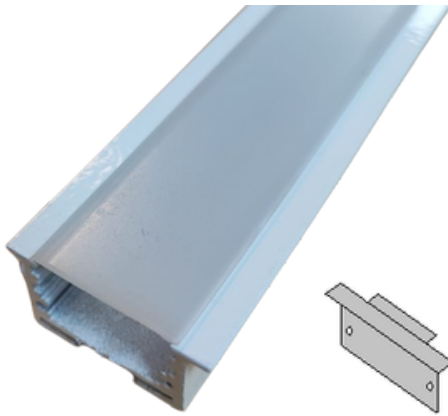

TAMPA / CABECEIRA

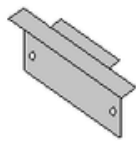

A	B	C	D	NICHO	COMPRIMENTO
28	16	23	33	25 X COMP.	METRO LINEAR

OBS.: DRIVER EM PONTO REMOTO

MEDIDAS EM MM



MOLA DE FIXAÇÃO

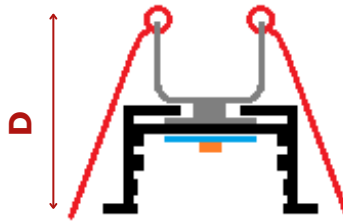

CONJUNTO MONTADO

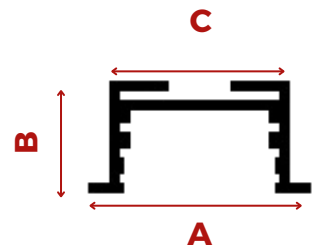

INDICADO PARA USO DE FITA LED SMD E COB, EM 12V OU 24V, APLICADA COM FITA DUPLA FACE DIRETAMENTE NO PERFIL - **PLACA LED SOB CONSULTA.**

SIMULAÇÃO DA PEÇA INSTALADA NO FORRO:



SUPORTES DE FIXAÇÃO ENTRE PERFIS

SUPORTES DE FIXAÇÃO DE CANTO

MOLA DE FIXAÇÃO



120°



IP20



1 ANO GARANTIA

O PERFIL **LINEAR LED PFE** É FABRICADO EM DIVERSOS TAMANHOS, ATENDENDO A UMA VARIADA GAMA DE APLICAÇÕES.

MATERIAL:
PERFIL EM ALUMÍNIO EXTRUDADO E DIFUSOR EM POLIESTIRENO TRANSLÚCIDO.

PFE-02

“PERFIL EMBUTIDO” (LARGO - FITA LED)



A	B	C	NICHO	COMPRIMENTO
78	65	55	58 X COMP.	METRO LINEAR

MEDIDAS EM MM

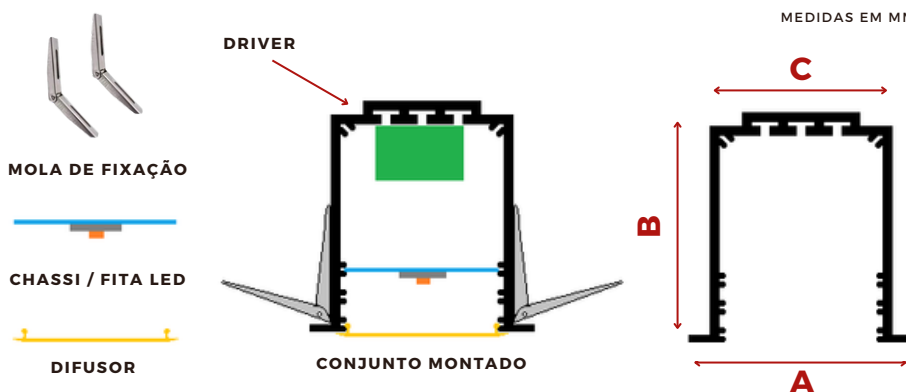

INDICADO PARA USO DE **FITA LED SMD E COB**, EM **12V OU 24V**, APLICADA COM FITA DUPLA FACE SOB CHASSI - POSTERIORMENTE FIXADO NO PERFIL - **PLACA LED SOB CONSULTA**.

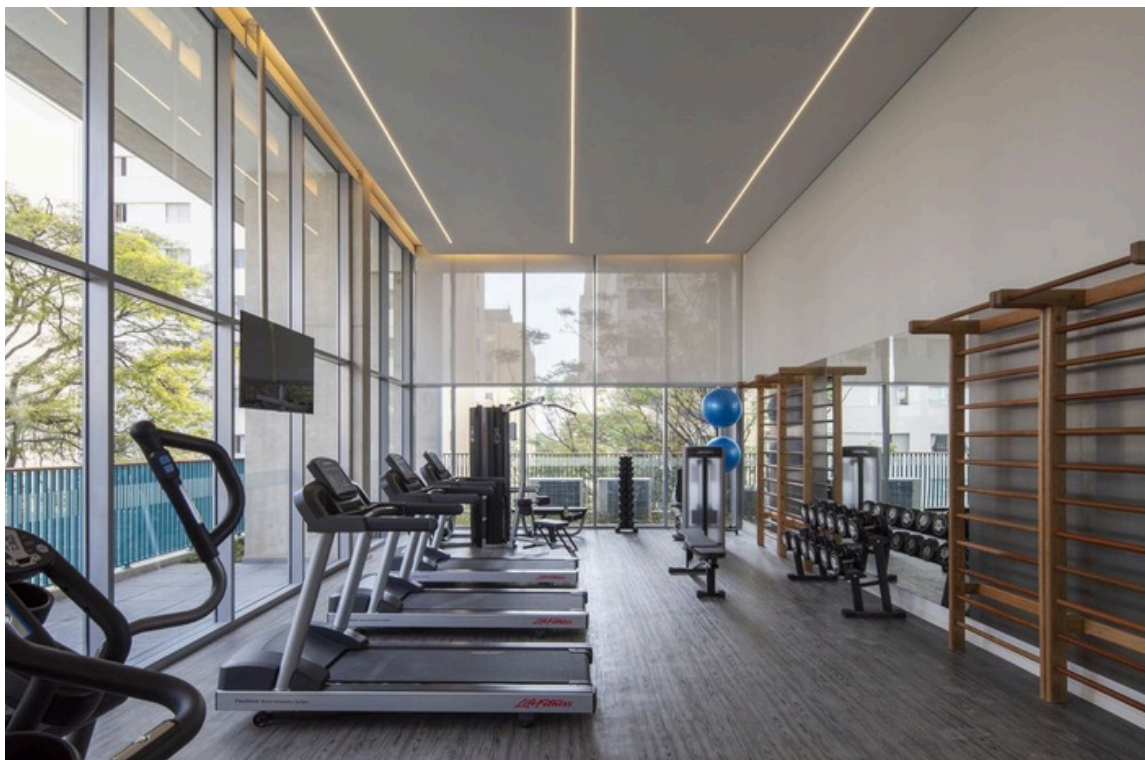

DEVIDO A CONSTANTE BUSCA DE APERFEIÇOAMENTO, OS PRODUTOS NEW LUMALUX ESTÃO SUJEITOS A ALTERAÇÕES SEM PRÉVIA COMUNICAÇÃO

O PERFIL **MOB LED PFE** É PARA **USO EXCLUSIVO EM MOBILIÁRIO**, DEVIDO AO SEU TAMANHO REDUZIDO E SISTEMA DE FIXAÇÃO.

MATERIAL:
PERFIL EM ALUMÍNIO EXTRUDADO E DIFUSOR EM POLIESTIRENO TRANSLÚCIDO.



PFE-03

“PERFIL EMBUTIDO” (SUPER BAIXO - MOBILIÁRIO)

A	B	C	NICHO	COMPRIMENTO
24	7	17	19 X COMP.	METRO LINEAR

OBS.: DRIVER EM PONTO REMOTO

MEDIDAS EM MM



MOLA DE FIXAÇÃO



CONJUNTO MONTADO

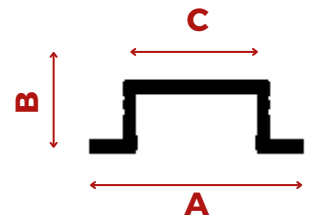

INDICADO **APENAS** PARA USO DE **FITA LED COB** (PARA NÃO MARCAR O DIFUSOR), EM **12V** OU **24V**, APLICADA COM FITA DUPLA FACE DIRETAMENTE NO PERFIL.



120°



IP20



1 ANO

GARANTIA

DEVIDO A CONSTANTE BUSCA DE APERFEIÇOAMENTO, OS PRODUTOS NEW LUMALUX ESTÃO SUJEITOS A ALTERAÇÕES SEM PRÉVIA COMUNICAÇÃO

O PERFIL **LINEAR LED PFE** É FABRICADO EM DIVERSOS TAMANHOS, ATENDENDO A UMA VARIADA GAMA DE APLICAÇÕES.

MATERIAL:
PERFIL EM ALUMÍNIO EXTRUDADO E DIFUSOR EM POLIESTIRENO TRANSLÚCIDO.

PFE-04

“PERFIL EMBUTIDO” (MÉDIO - FITA LED)

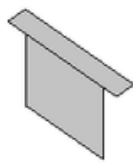
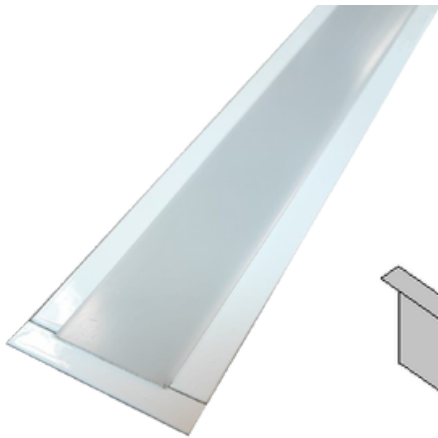

TAMPA /
CABECEIRA

A	B	C	NICHO	COMPRIMENTO
54	35	35	37 X COMP	METRO LINEAR

OBS.: DRIVER EM PONTO REMOTO

MEDIDAS EM MM

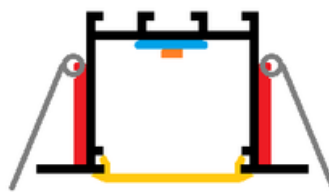

CONJUNTO MONTADO

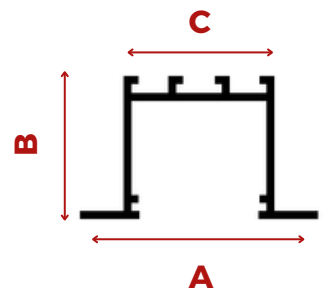

INDICADO PARA USO DE **FITA LED SMD E COB**, EM 12V OU 24V, APLICADA COM FITA DUPLA FACE DIRETAMENTE NO PERFIL - **PLACA LED SOB CONSULTA**.



120°



IP20



1 ANO

GARANTIA

DEVIDO A CONSTANTE BUSCA DE APERFEIÇOAMENTO, OS PRODUTOS NEW LUMALUX ESTÃO SUJEITOS A ALTERAÇÕES SEM PRÉVIA COMUNICAÇÃO

O PERFIL **LINEAR LED SANCA** É FABRICADO PARA FORRO DE GESSO, POIS POSSUI ACABAMENTO DO TIPO “NO FRAME”

MATERIAL:
PERFIL EM ALUMÍNIO EXTRUDADO

PFE-05

“PERFIL SANCA EMBUTIDO” (MÉDIO - FITA LED)

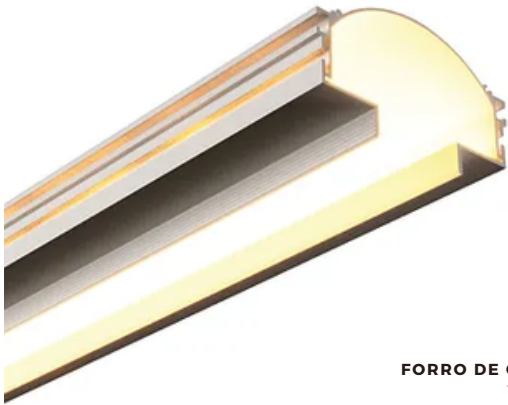

A	B	C	COMPRIMENTO
95	59	38	METRO LINEAR

OBS.: DRIVER EM PONTO REMOTO

MEDIDAS EM MM

FORRO DE GESSO

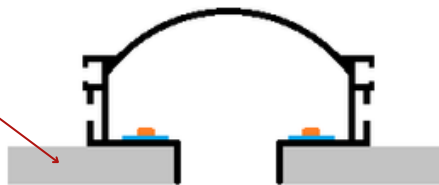

CONJUNTO MONTADO

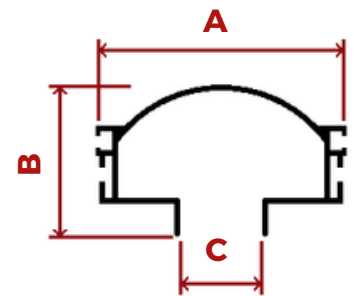

CADA PERFIL ACOMPANHA 2 TAMPAS DE FECHAMENTO

OBS.: ESTE PRODUTO DEMANDA INSTALAÇÃO EM CONJUNTO COM O FORRO DE GESSO.

INDICADO PARA USO DE 2 FITAS LED SMD E COB (UMA DE CADA LADO DO PERFIL) EM 12V OU 24V, APLICADAS COM FITA DUPLA FACE DIRETAMENTE NO PERFIL.

2 FITAS LED (NAS LATERAIS)

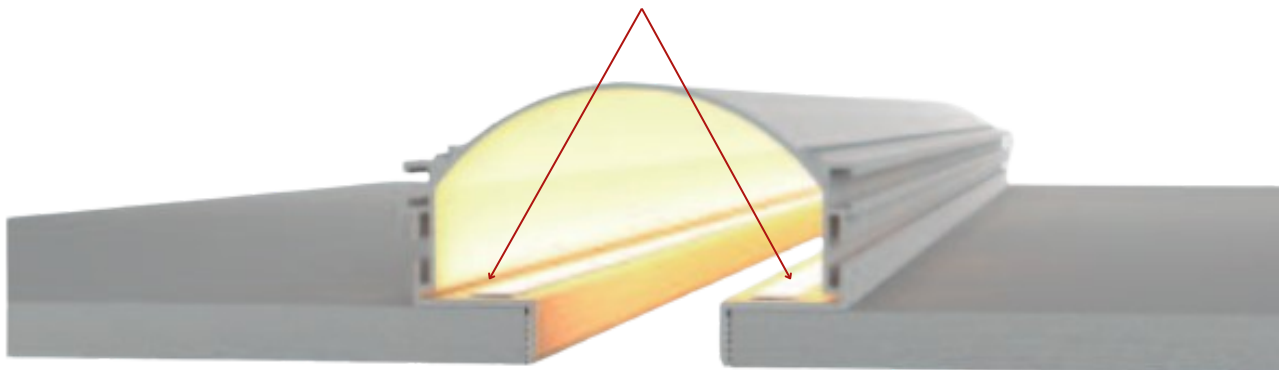

DEVIDO A CONSTANTE BUSCA DE APERFEIÇOAMENTO, OS PRODUTOS NEW LUMALUX ESTÃO SUJEITOS A ALTERAÇÕES SEM PRÉVIA COMUNICAÇÃO

PERFIS DE SOBREPOR

O PERFIL **LINEAR LED PFS** É FABRICADO EM DIVERSOS TAMANHOS, ATENDENDO A UMA VARIADA GAMA DE APLICAÇÕES.

MATERIAL:
PERFIL EM ALUMÍNIO EXTRUDADO E DIFUSOR EM POLIESTIRENO TRANSLÚCIDO.



PFS-01

“PERFIL APLICADO” (ESTREITO - FITA LED)

A	B	C	COMPRIMENTO
23	13	14	METRO LINEAR

MEDIDAS EM MM

OBS.: DRIVER EM PONTO REMOTO



INDICADO PARA USO DE **FITA LED SMD** E **COB**, EM **12V** OU **24V**, APLICADA COM FITA DUPLA FACE DIRETAMENTE NO PERFIL - **PLACA LED SOB CONSULTA**.



DEVIDO A CONSTANTE BUSCA DE APERFEIÇOAMENTO, OS PRODUTOS NEW LUMALUX ESTÃO SUJEITOS A ALTERAÇÕES SEM PRÉVIA COMUNICAÇÃO

O PERFIL **LINEAR LED PFS** É FABRICADO EM DIVERSOS TAMANHOS, ATENDENDO A UMA VARIADA GAMA DE APLICAÇÕES.

MATERIAL:
PERFIL EM ALUMÍNIO EXTRUDADO E DIFUSOR EM POLIESTIRENO TRANSLÚCIDO.

PFS-02

“PERFIL APLICADO” (LARGO - FITA LED)

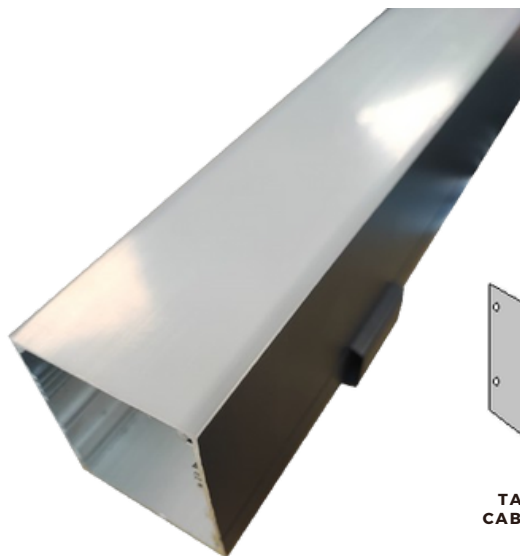

A	B	C	COMPRIMENTO
60	70	78	METRO LINEAR

MEDIDAS EM MM

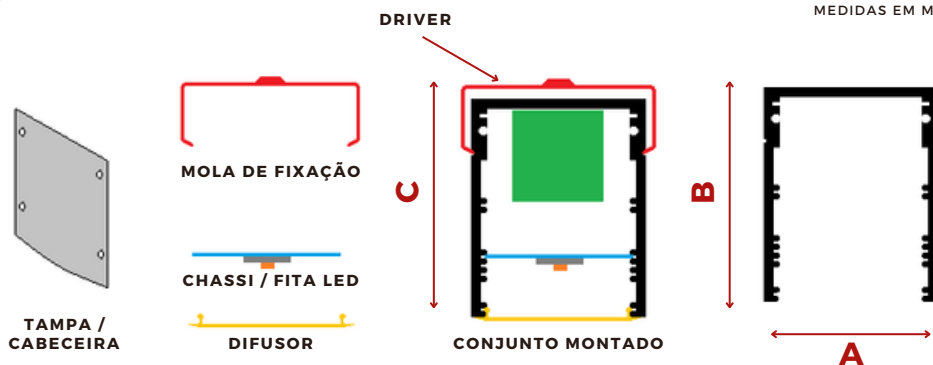

INDICADO PARA USO DE **FITA LED SMD E COB**, EM 12V OU 24V, APLICADA COM FITA DUPLA FACE SOB CHASSI - POSTERIORMENTE FIXADO NO PERFIL - **PLACA LED SOB CONSULTA**.



DEVIDO A CONSTANTE BUSCA DE APERFEIÇOAMENTO, OS PRODUTOS NEW LUMALUX ESTÃO SUJEITOS A ALTERAÇÕES SEM PRÉVIA COMUNICAÇÃO

O PERFIL MOB LED PFS É PARA **USO EXCLUSIVO EM MOBILIÁRIO**, DEVIDO AO SEU TAMANHO REDUZIDO E SISTEMA DE FIXAÇÃO.

MATERIAL:
PERFIL EM ALUMÍNIO EXTRUDADO E DIFUSOR EM POLIESTIRENO TRANSLÚCIDO.

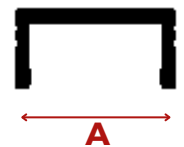

PFS-03

“PERFIL APLICADO” (SUPER BAIXO - MOBILIÁRIO)

A	B	C	COMPRIMENTO
17	7	9	METRO LINEAR

OBS.: DRIVER EM PONTO REMOTO

MEDIDAS EM MM

INDICADO **APENAS** PARA USO DE **FITA LED COB** (PARA NÃO MARCAR O DIFUSOR), EM **12V** OU **24V**, APLICADA COM FITA DUPLA FACE DIRETAMENTE NO PERFIL.



DEVIDO A CONSTANTE BUSCA DE APERFEIÇOAMENTO, OS PRODUTOS NEW LUMALUX ESTÃO SUJEITOS A ALTERAÇÕES SEM PRÉVIA COMUNICAÇÃO

O PERFIL **LINEAR LED PFS** É FABRICADO EM DIVERSOS TAMANHOS, ATENDENDO A UMA VARIADA GAMA DE APLICAÇÕES.

MATERIAL:
PERFIL EM ALUMÍNIO EXTRUDADO E DIFUSOR EM POLIESTIRENO TRANSLÚCIDO.

PFS-04

“PERFIL APLICADO” (MÉDIO - FITA LED)

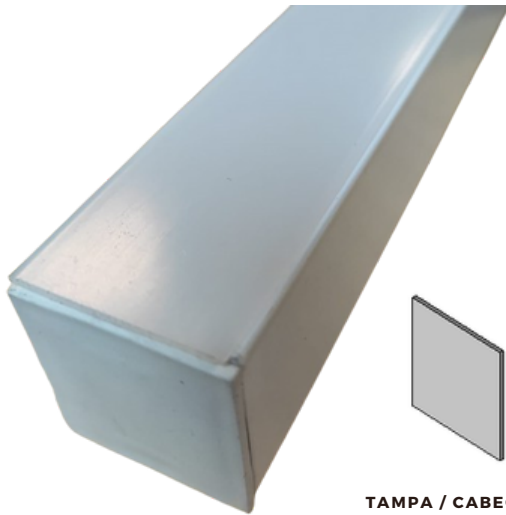

A	B	C	COMPRIMENTO
35	35	36	METRO LINEAR

OBS.: DRIVER EM PONTO REMOTO

MEDIDAS EM MM

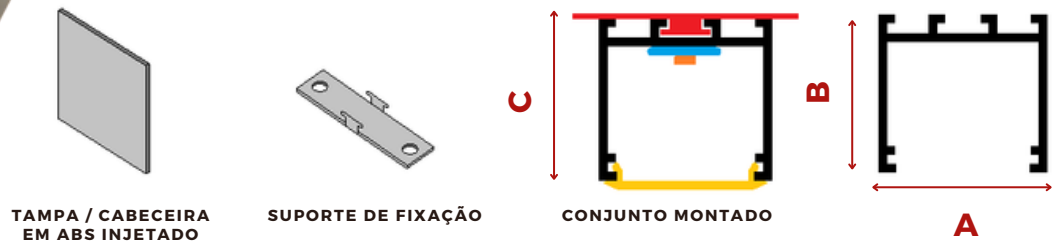

INDICADO PARA USO DE **FITA LED SMD E COB**, EM 12V OU 24V, APLICADA COM FITA DUPLA FACE DIRETAMENTE NO PERFIL - **PLACA LED SOB CONSULTA**.

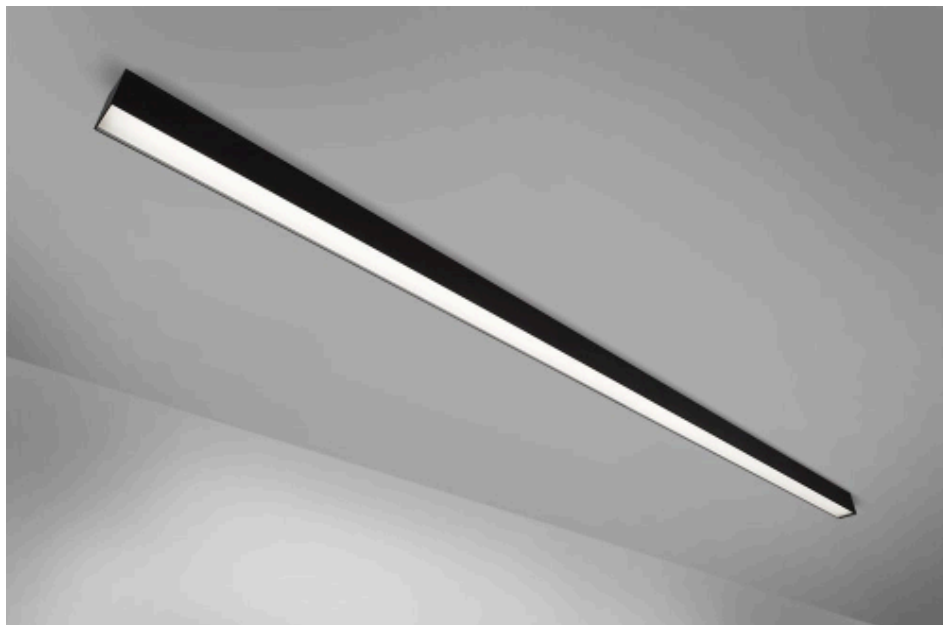

DEVIDO A CONSTANTE BUSCA DE APERFEIÇOAMENTO, OS PRODUTOS NEW LUMALUX ESTÃO SUJEITOS A ALTERAÇÕES SEM PRÉVIA COMUNICAÇÃO

PERFIS PENDENTES

O PERFIL **LINEAR LED PFP** É FABRICADO EM DIVERSOS TAMANHOS, ATENDENDO A UMA VARIADA GAMA DE APLICAÇÕES.

MATERIAL:
PERFIL EM ALUMÍNIO EXTRUDADO E DIFUSOR EM POLIESTIRENO TRANSLÚCIDO.

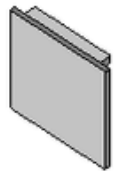

TAMPA / CABECEIRA

PFP-01

“PERFIL PENDENTE”
(ESTREITO COM DIFUSOR ALTO - FITA LED)

A	B	C	COMPRIMENTO
19	10	19	METRO LINEAR

MEDIDAS EM MM

OBS.: DRIVER EM PONTO REMOTO

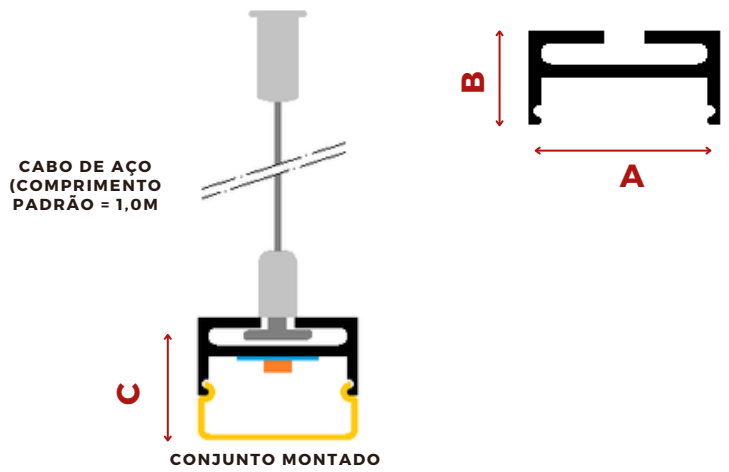

INDICADO PARA USO DE **FITA LED SMD** E **COB**, EM **12V** OU **24V**, APLICADA COM FITA DUPLA FACE DIRETAMENTE NO PERFIL - **PLACA LED SOB CONSULTA.**



DEVIDO A CONSTANTE BUSCA DE APERFEIÇOAMENTO, OS PRODUTOS NEW LUMALUX ESTÃO SUJEITOS A ALTERAÇÕES SEM PRÉVIA COMUNICAÇÃO

O PERFIL **LINEAR LED PFS** É FABRICADO EM DIVERSOS TAMANHOS, ATENDENDO A UMA VARIADA GAMA DE APLICAÇÕES.

MATERIAL:
PERFIL EM ALUMÍNIO EXTRUDADO E DIFUSOR EM POLIESTIRENO TRANSLÚCIDO.

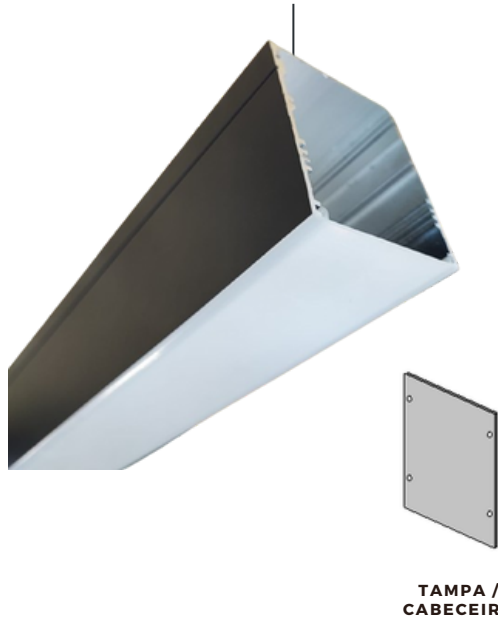

PFP-02

“PERFIL PENDENTE” (LARGO - FITA LED)

A	B	COMPRIMENTO
60	70	METRO LINEAR

MEDIDAS EM MM

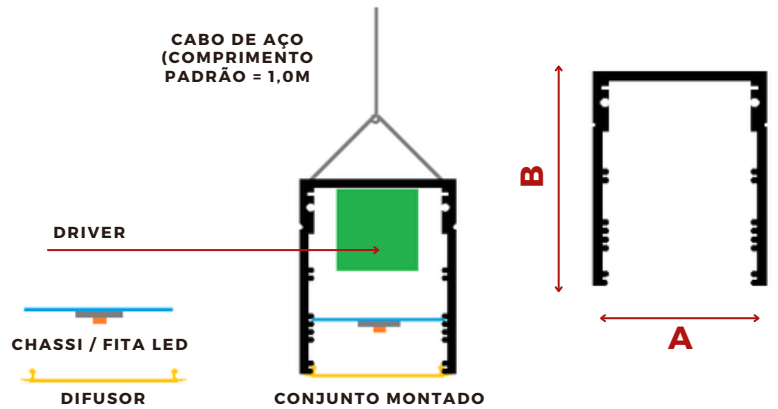

INDICADO PARA USO DE **FITA LED SMD** E **COB**, EM **12V** OU **24V**, APLICADA COM FITA DUPLA FACE SOB CHASSI - POSTERIORMENTE FIXADO NO PERFIL - **PLACA LED SOB CONSULTA**.

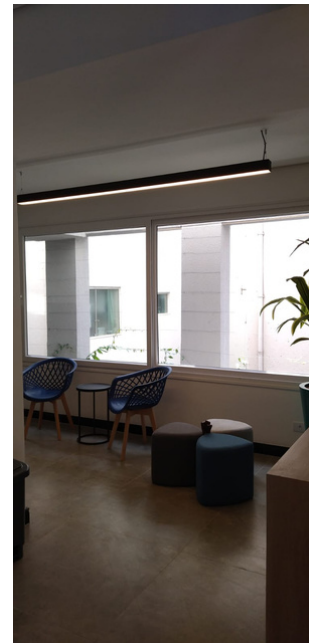

DEVIDO A CONSTANTE BUSCA DE APERFEIÇOAMENTO, OS PRODUTOS NEW LUMALUX ESTÃO SUJEITOS A ALTERAÇÕES SEM PRÉVIA COMUNICAÇÃO

O PERFIL **LINEAR LED PFS** É FABRICADO EM DIVERSOS TAMANHOS, ATENDENDO A UMA VARIADA GAMA DE APLICAÇÕES.

MATERIAL:
PERFIL EM ALUMÍNIO EXTRUDADO E DIFUSOR EM POLIESTIRENO TRANSLÚCIDO.

PFP-03

“PERFIL PENDENTE” (LARGO - DIRETO E INDIRETO FITA LED)

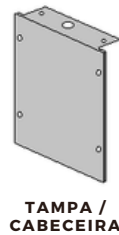

CHASSI / FITA LED
DIFUSOR

DRIVER

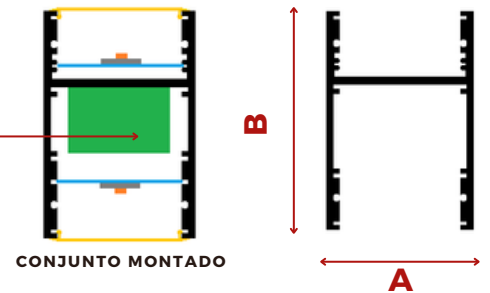

MEDIDAS EM MM

INDICADO PARA USO DE FITA LED SMD E COB, EM 12V OU 24V, APLICADA COM FITA DUPLA FACE SOB CHASSI - POSTERIORMENTE FIXADO NO PERFIL - **PLACA LED SOB CONSULTA.**



EXEMPLO DE UTILIZAÇÃO

PENDENTE COM PERFIL DIRETO E INDIRETO - 1,5M DE COMPRIMENTO

VISTA SUPERIOR DA FIXAÇÃO DO CBO DE AÇO

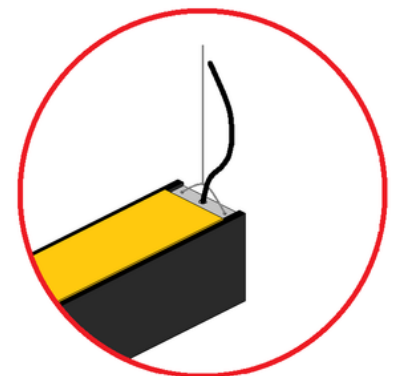

O PERFIL **LINEAR LED PFP** É FABRICADO EM DIVERSOS TAMANHOS, ATENDENDO A UMA VARIADA GAMA DE APLICAÇÕES.

MATERIAL:
PERFIL EM ALUMÍNIO EXTRUDADO E DIFUSOR EM POLIESTIRENO TRANSLÚCIDO.

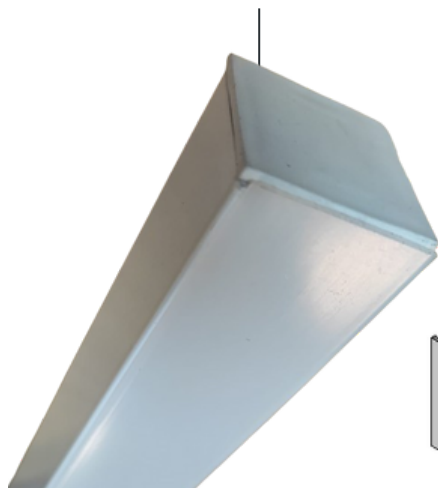

PFP-04

“PERFIL APLICADO” (MÉDIO - FITA LED)

A	B	C	COMPRIMENTO
35	35	38	METRO LINEAR

OBS.: DRIVER EM PONTO REMOTO

MEDIDAS EM MM

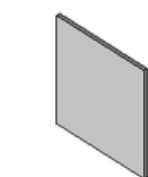

TAMPA / CABECEIRA
EM ABS INJETADO

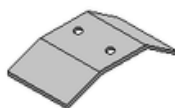

SUPORTE DE FIXAÇÃO

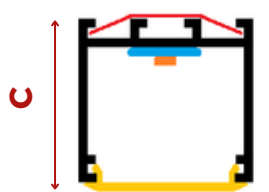

CONJUNTO MONTADO

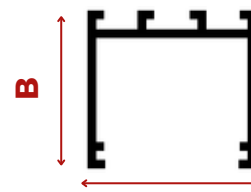

A

INDICADO PARA USO DE **FITA LED SMD E COB**, EM 12V OU 24V, APLICADA COM FITA DUPLA FACE DIRETAMENTE NO PERFIL - **PLACA LED SOB CONSULTA**.



PERFIS DE CANTO

O PERFIL **LINEAR LED PFC** É FABRICADO EM DIVERSOS TAMANHOS, ATENDENDO A UMA VARIADA GAMA DE APLICAÇÕES.

MATERIAL:
PERFIL EM ALUMÍNIO EXTRUDADO E DIFUSOR EM POLIESTIRENO TRANSLÚCIDO.

PFC-01

“PERFIL DE CANTO” (ESTREITO - FITA LED)



MOLA DE FIXAÇÃO



TAMPA /
CABECEIRA

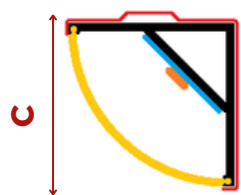

CONJUNTO MONTADO

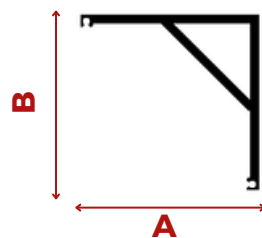

A

A	B	C	COMPRIMENTO
15	15	19	METRO LINEAR

MEDIDAS EM MM

OBS.: DRIVER EM PONTO REMOTO

INDICADO **APENAS** PARA USO DE FITA LED SMD OU COB, EM 12V OU 24V, APLICADA COM FITA DUPLA FACE DIRETAMENTE NO PERFIL.



WALL WASHER

IP20

1 ANO
GARANTIA

DEVIDO A CONSTANTE BUSCA DE APERFEIÇOAMENTO, OS PRODUTOS NEW LUMALUX ESTÃO SUJEITOS A ALTERAÇÕES SEM PRÉVIA COMUNICAÇÃO

O PERFIL **LINEAR LED PFC** É FABRICADO EM DIVERSOS TAMANHOS, ATENDENDO A UMA VARIADA GAMA DE APLICAÇÕES.

MATERIAL:
PERFIL EM ALUMÍNIO EXTRUDADO E DIFUSOR EM POLIESTIRENO TRANSLÚCIDO.

PFC-02

“PERFIL RODAPÉ” (LUZ DIRETA OU INDIRETA - FITA LED)



A	B	COMPRIMENTO
23	46	METRO LINEAR

OBS.: DRIVER EM PONTO REMOTO

MEDIDAS EM MM



INDICADO **APENAS** PARA USO DE FITA LED SMD OU COB, EM 12V OU 24V, APLICADA COM FITA DUPLA FACE DIRETAMENTE NO PERFIL.

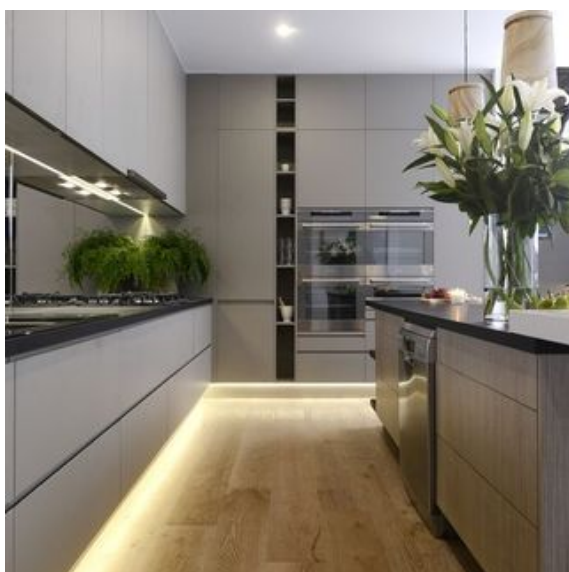

DEVIDO A CONSTANTE BUSCA DE APERFEIÇOAMENTO, OS PRODUTOS NEW LUMALUX ESTÃO SUJEITOS A ALTERAÇÕES SEM PRÉVIA COMUNICAÇÃO

PERFIS DE PAREDE

O PERFIL **LINEAR LED PFA** É FABRICADO EM DIVERSOS TAMANHOS, ATENDENDO A UMA VARIADA GAMA DE APLICAÇÕES.

MATERIAL:
PERFIL EM ALUMÍNIO EXTRUDADO E DIFUSOR EM POLIESTIRENO TRANSLÚCIDO.

PFA-01

“PERFIL ARANDELA”
(LARGO - LUZ DIRETA OU INDIRETA
- FITA LED)

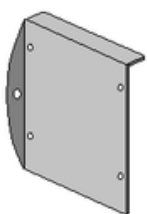
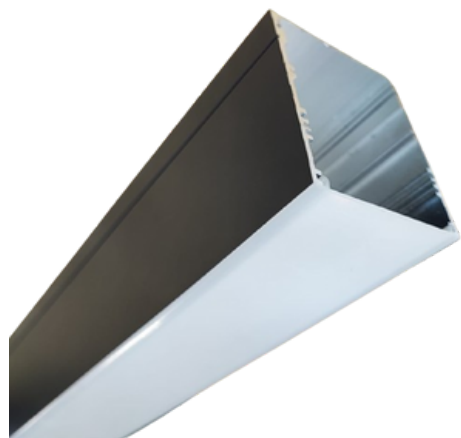

TAMPA /
CABECEIRA

CHASSI / FITA LED

DIFUSOR

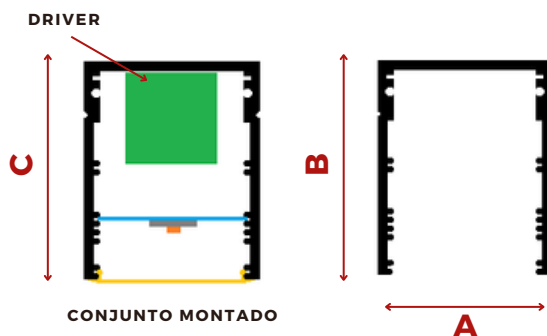

MEDIDAS EM MM

A	B	C	COMPRIMENTO
60	70	78	METRO LINEAR

INDICADO PARA USO DE **FITA LED SMD** E **COB**, EM **12V** OU **24V**, APLICADA COM FITA DUPLA FACE SOB CHASSI - POSTERIORMENTE FIXADO NO PERFIL - **PLACA LED SOB CONSULTA**.

MONTAGEM COM LUZ INDIRETA



MONTAGEM COM LUZ DIRETA



DEVIDO A CONSTANTE BUSCA DE APERFEIÇOAMENTO, OS PRODUTOS NEW LUMALUX ESTÃO SUJEITOS A ALTERAÇÕES SEM PRÉVIA COMUNICAÇÃO

O PERFIL **LINEAR LED PFA** É FABRICADO EM DIVERSOS TAMANHOS, ATENDENDO A UMA VARIADA GAMA DE APLICAÇÕES.

MATERIAL:
PERFIL EM ALUMÍNIO EXTRUDADO E DIFUSOR EM POLIESTIRENO TRANSLÚCIDO.

PFA-02

“PERFIL ARANDELA”
(LARGO - DIRETO E INDIRETO FITA LED)



VISTA SUPERIOR



VISTA INFERIOR

A	B	COMPRIMENTO
60	80	METRO LINEAR

MEDIDAS EM MM

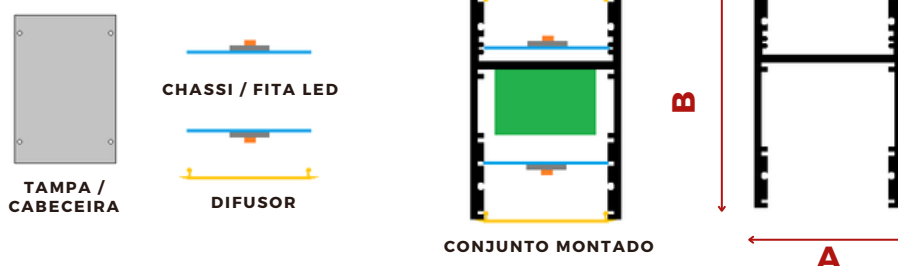

INDICADO PARA USO DE FITA LED SMD E COB, EM 12V OU 24V, APLICADA COM FITA DUPLA FACE SOB CHASSI - POSTERIORMENTE FIXADO NO PERFIL - **PLACA LED SOB CONSULTA.**

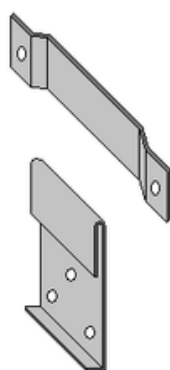

SUPORTES DE FIXAÇÃO



O PERFIL **LINEAR LED PFA** É FABRICADO EM DIVERSOS TAMANHOS, ATENDENDO A UMA VARIADA GAMA DE APLICAÇÕES.

MATERIAL:
PERFIL EM ALUMÍNIO EXTRUDADO E DIFUSOR EM POLIESTIRENO TRANSLÚCIDO.

PFA-03

“PERFIL ARANDELA”
(LARGO - LUZ DIRETA E INDIRETA - FITA LED)



A	B	C	COMPRIMENTO
70	40	20	METRO LINEAR

OBS.: DRIVER EM PONTO REMOTO

MEDIDAS EM MM



MOLAS DE FIXAÇÃO

TAMPAS / CABECEIRAS

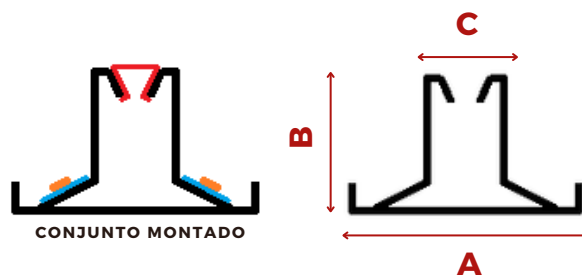

INDICADO PARA USO DE **FITA LED SMD E COB**, EM 12V OU 24V, APLICADA COM FITA DUPLA FACE SOB CHASSI - POSTERIORMENTE FIXADO NO PERFIL - **PLACA LED SOB CONSULTA**.



NEW
LUMALUX
ILUMINAÇÃO

FÁBRICA:
RUA SÃO JOÃO CLIMACO, 162
04255-000 - SÃO PAULO-SP

ESCRITÓRIO E SHOW ROOM:
RUA SÃO JOÃO CLIMACO, 218
04255-000 - SÃO PAULO-SP
11 2083-0018
11 2083-6144

ACOMPANHE-NOS NAS REDES
SOCIAIS:



@NEWLUMALUX_



LINKEDIN



WWW.LUMALUX.COM.BR

